

WBC2730,WBC2736,WBC2742

ASSEMBLY INSTUCTIONS

Getting started:

prepare a protection layer, a screwdriver

STEP 1: Joint side panel with back panel

STEP 2: Joint top panel with side panel

STEP 3: Joint bottom panel with side panel

STEP 4: Attach frame on





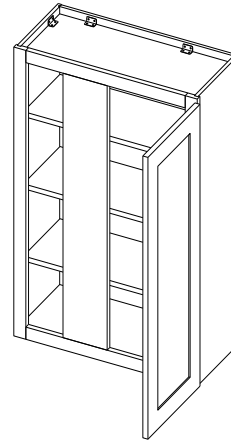

STEP 5: Put on the adjustable shelves

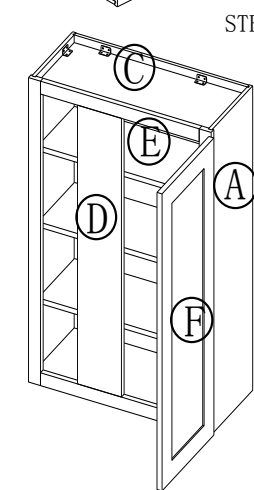
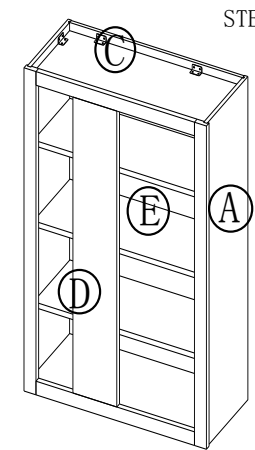
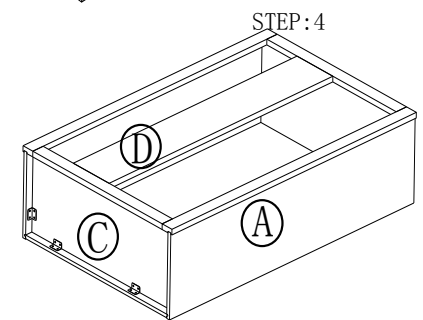
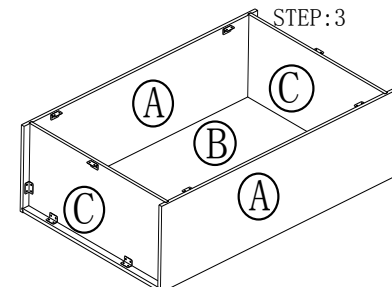
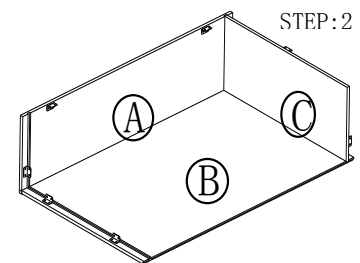
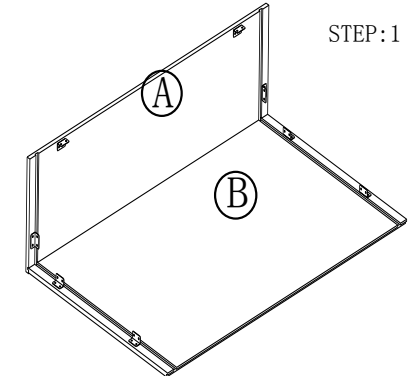
STEP 6: Fix door onto the frame and adjust the cover-space

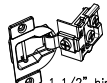

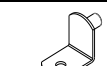
PARTS LIST		
NO.	Description	QTY
A	SIDE PANEL	2
B	BACK PANEL	1
C	TOP&BOTTOM PANEL	2
D	FACE FRAME	1
E	ADJUSTABLE SHELF	2
F	CABINETS DOOR	1



7	1 1/2" SOFTCLOSE HINGE	2	 1 1/2" hinge
6	3/4" ROUND HEAD SCREW	2	 3/4" round head screw
5	BUMPER	2	 Bumper
4	SHELF CLIP	8	 Shelf clip
3	9/16"ROUND HEAD SCREW	56	 9/16" round head screw
2	CLEAT	14	 Cleat
1	1"FLAT HEAD SCREW FOR CARCASS	6	 1" flat head screw
NO.	Description	QTY	PICTURE

HARDWARE LIST