

W3012,W3612,W3015,W3615,W361524,W3018,W3618,W361824,W361224

ASSEMBLY INSTUCTIONS

Getting started:

prepare a protection layer, a screwdriver

STEP 1: Joint side panel with back panel

STEP 2: Joint side panel with back panel and attaching top panel for giving support



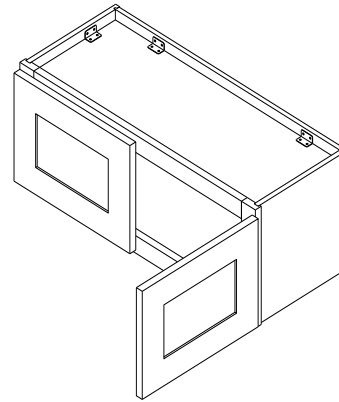

STEP 3: Joint back panel with side panel and back panel

STEP 4: Attach frame on

STEP 5: Fix door onto the frame and adjust the cover-space

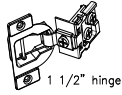

PARTS LIST		
NO.	Description	QTY
A	SIDE PANEL	2
B	BACK PANEL	1
C	TOP&BOTTOM PANEL	2
D	FACE FRAME	1
E	CABINETS DOOR	2

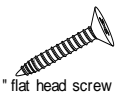
6	1 1/2" SOFTCLOSE HINGE	4	 1 1/2" hinge
5	3/4" ROUND HEAD SCREW	4	 3/4" round head screw
4	BUMPER	4	 Bumper
3	9/16"ROUND HEAD SCREW	56	 9/16" round head screw
2	CLEAT	14	 Cleat
1	1"FLAT HEAD SCREW FOR CARCASS	8	 1" flat head screw
NO.	Description	QTY	PICTURE

HARDWARE LIST

