

V3621DL&DR

ASSEMBLY INSTRUCTIONS

Getting started:

prepare a protection layer, a screwdriver

STEP 1: Joint side panel with back panel

STEP 2: Joint bottom panel with side panel

STEP 3: Joint side panel with bottom & back panel

STEP 4: Attach frame on and toekick board

STEP 5: Joint the drawer together, then install the drawer guide.

STEP 6: Attach the block on the top corner.

STEP 7: Fix drawer head on the drawer front and fix door onto the frame and adjust the cover-space

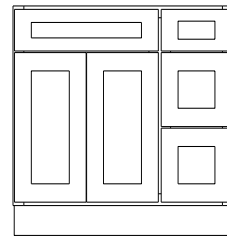
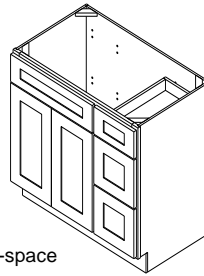



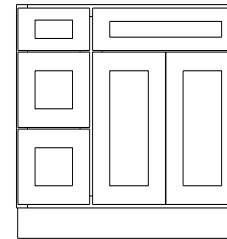







V3621DR

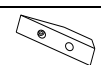

V3621DL

PARTS LIST		
NO.	Description	QTY
A	BACK PANEL	1
B	SIDE PANEL	2
C	TOP&BOTTOM PANEL	1
D	TOE KICK	1
E	FACE FRAME	1
F	DRAWER BOX FRONT AND BACK	6
G	DRAWER BOX SIDE	6
H	DRAWER BOX BOTTOM	3
I	CABINETS DOOR	2
J	DRAWER HEAD	4

10	1 1/2" SOFTCLOSE HINGE	4	
9	3/4" ROUND HEAD SCREW	4	
8	BUMPER	16	
7	1" ROUND HEAD SCREW	12	
6	Selfclose slider	3	
5	9/16" ROUND HEAD SCREW	44	
4	CLEAT	11	
3	1" FLAT HEAD SCREW FOR CARCASS	4	
2	BLOCK	4	
1	1" FLAT HEAD SCREW FOR WOOD BLOCK	8	
NO.	Description	QTY	PICTURE

HARDWARE LIST

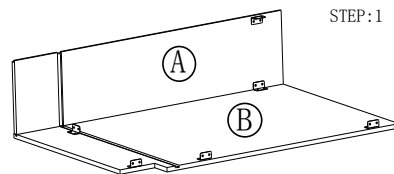

STEP:1

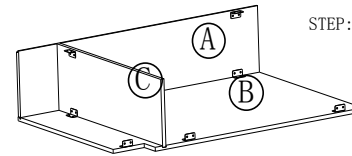

STEP:2

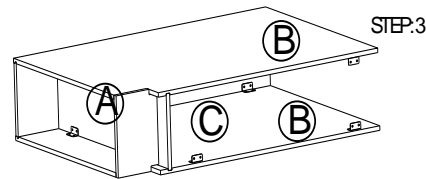

STEP:3

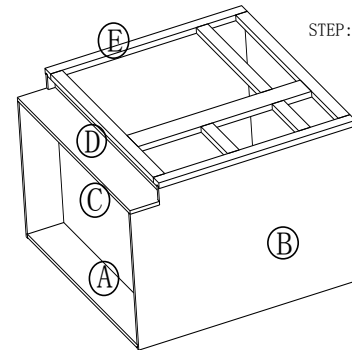

STEP:4

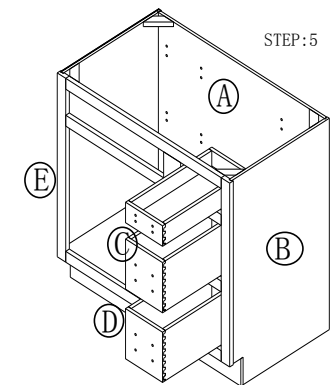

STEP:5

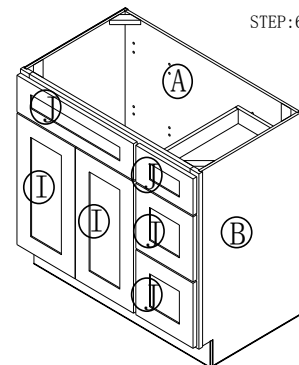

STEP:6

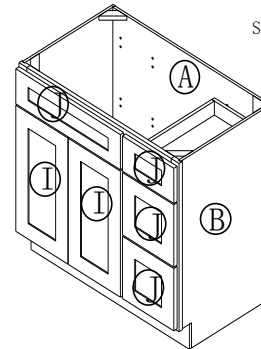

STEP:7

Full extension concealed drawer runners

