

DCW2430,DCW2436,DCW2442,DCW****GD
DCW2730,DCW2736,DCW2742

ASSEMBLY INSTUCTIONS

Getting started:

prepare a protection layer, a screwdriver

STEP 1: Joint side panel with front face frame

STEP 2: Attach top panel with front face frame and side panel

STEP 3: Attach top panel with front face frame and side panel

STEP 4: Attach back panel on side panel

STEP 5: Insert back panel through groove, then screw up

STEP 6: Hing door on to front face frame and adjust the cover-space

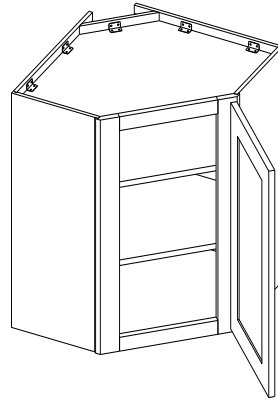

PARTS LIST		
NO.	Description	QTY
A	FACE FRAME	1
B	SIDE PANEL	2
C	TOP&BOTTOM PANEL	2
D	BACK PANEL	2
E	BACK PANEL	1
F	ADJUSTABLE SHELF	2
G	CABINETS DOOR	1

STEP:1

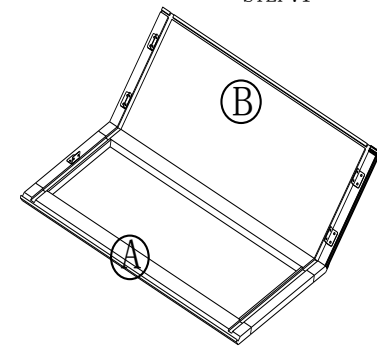

STEP:2

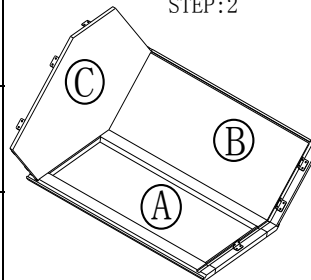

STEP:3

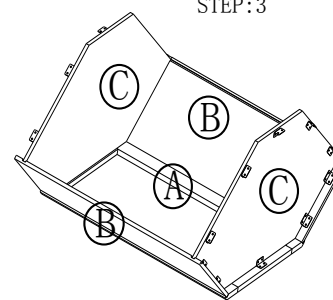

STEP:4

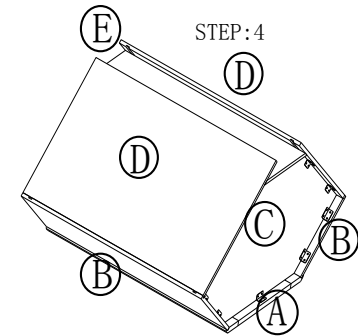



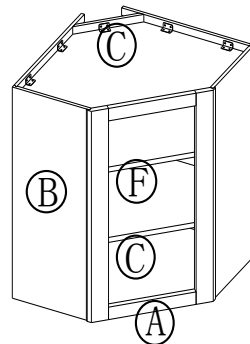



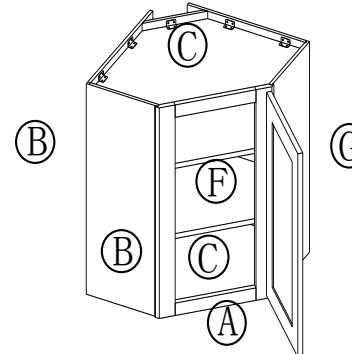

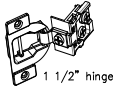
STEP:5



STEP:6



8	1 1/2" SOFTCLOSE HINGE	2	 1 1/2" hinge
7	3/4" ROUND HEAD SCREW	2	 3/4" round head screw
6	BUMPER	2	 Bumper
5	SHELF CLIP	10	 Shelf clip
4	9/16"ROUND HEAD SCREW	92	 9/16" round head screw
3	CLEAT	22	 Cleat
2	1"FLAT HEAD SCREW FOR CARCASS	6	 1" flat head screw
1	135 DEGREE ANGLE	2	 135° angle
NO.	Description	QTY	PICTURE

HARDWARE LIST