

BT9

ASSEMBLY INSTRUCTIONS

Getting started:

prepare a protection layer, a screwdriver

STEP 1: Joint side panel with back panel

STEP 2: Joint bottom panel with side panel

STEP 3: Joint side panel with bottom & back panel







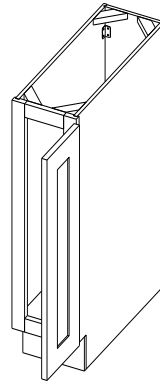

STEP 4: Attach frame on and toekick board

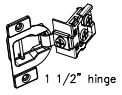
STEP 5: Attach the block on the top corner

STEP 6: Fix door onto the frame and adjust the cover-space

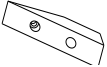

PARTS LIST		
NO.	Description	QTY
A	BACK PANEL	1
B	SIDE PANEL	2
C	TOP&BOTTOM PANEL	1
D	FACE FRAME	1
E	TOE KICK	1
F	CABINETS DOOR	1

8	1 1/2" SOFTCLOSE HINGE	2	 1 1/2" hinge
7	3/4" ROUND HEAD SCREW	2	 3/4" round head screw
6	BUMPER	2	 Bumper
5	9/16" ROUND HEAD SCREW	40	 9/16" round head screw
4	CLEAT	10	 Cleat
3	1" FLAT HEAD SCREW FOR CARCASS	2	 1" flat head screw
2	BLOCK	4	
1	1" FLAT HEAD SCREW FOR WOOD BLOCK	8	 1" flat head screw
NO.	Description	QTY	PICTURE

HARDWARE LIST

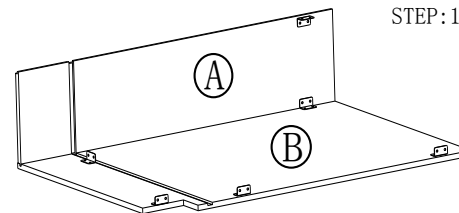

STEP:1

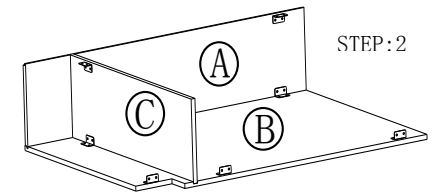

STEP:2

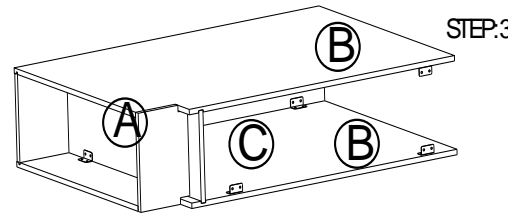

STEP:3

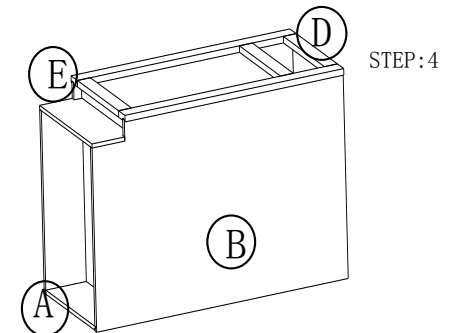

STEP:4

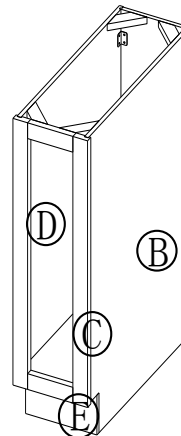

STEP:5

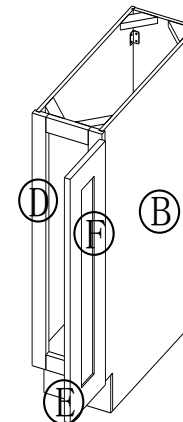

STEP:6